

Expansive motions

Robert Connelly *

October 2, 2006

Abstract

A polygonal chain in the plane without self-intersections can open expansively until it achieves a convex configuration. What can you add to the chain to insure that the whole object does not intersect itself as the core chain expands? What properties of the object insure that it has an expansive motion? Here an abbreviated history of some of the recent ideas, which have been used for solutions to some of these problems, is presented as well as some connections to related problems concerning areas of unions and intersections of disks.

MSC: 52C25, 52C35, 52Cxx, 52.50

Keywords: Carpenter's rule, expansive mappings, tensegrities

1 Carpenter's rule problems

In the 1970's Steve Schanuel asked whether any polygonal non-self-intersecting chain in the plane can be opened so that it becomes straight. The links have to stay the same length, and there can be no crossings or self-intersections during the motion. Later Sue Whitesides and Joe Mitchell asked the same question independently. (See [Connelly-Demaine-Rote] for more about this history.) In December of 1999 at a conference in Budapest, the original idea for a solution to this was found, which is described in detail in [Connelly-Demaine-Rote]. The following is a description of the main ideas and an overview of some of the related work that has gone on since then. See [Demaine-O'Rourke], for example for a good survey. See also [Asimow-Roth], [Asimow-Roth II], [Connelly], and [Connelly-Whiteley] for a more general introduction to the theory of rigid and non-rigid frameworks. There are essentially three observations that lead to a proof.

The first is an observation by Günter Rote that all of the previous examples of chains, which "seemed" to be locked so that they could not be opened, actually did open so that every pair of points on the chain expanded. In other words the distance between every pair of points on the chain either increased or stayed the same (if they were on collinear links). If this could be shown to be the case in general, even just locally, then that would insure that

*Research supported in part by NSF Grant No. DMS-0209595

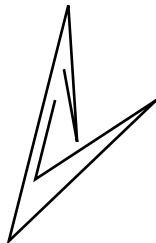

Figure 1: A polygonal chain in the plane.

no self-intersection could arise, and there would be no stopping its eventual opening until the chain becomes straight.

The second observation is that the local problem of whether there is a small perturbation that opens the chain is essentially about the rigidity of a tensegrity structure. The links in the chain are bars, that cannot change their length, and between every other pair of vertices of the chain, not on a straight line of links, place a strut. Struts are allowed to increase their length but not decrease their length. When the chain is not straight, the idea is to show that this tensegrity is NOT rigid. But there are techniques for showing that tensegrities are rigid or not rigid. The first thing to test is first-order rigidity, also known as infinitesimal rigidity and equivalently static rigidity. An infinitesimal motion is a vector \mathbf{p}'_i assigned to each vertex \mathbf{p}_i of the tensegrity such that $(\mathbf{p}_i - \mathbf{p}_j)(\mathbf{p}'_i - \mathbf{p}'_j) \geq 0$ for each strut connecting \mathbf{p}_i to \mathbf{p}_j , with equality when there is a bar connecting \mathbf{p}_i to \mathbf{p}_j . If there always is such an infinitesimal motion \mathbf{p}' , and it can be chosen sufficiently smoothly and in such a way that the strut inequalities are strict, then the opening motion can be obtained simply by integrating the vector field defined on the appropriate portion of the configuration space.

But there is a standard dual version of first-order rigidity called static rigidity. An *equilibrium stress* on a tensegrity is an assignment of a scalar $\omega_{ij} = \omega_{ji}$ to each strut or bar such that at each vertex \mathbf{p}_i , $\sum_j \omega_{ij}(\mathbf{p}_j - \mathbf{p}_i) = \mathbf{0}$. The equilibrium stress is called *proper* if $\omega_{ij} \leq 0$ when there is a strut between \mathbf{p}_i and \mathbf{p}_j . There is no condition on the sign of ω_{ij} when there is a bar between \mathbf{p}_i and \mathbf{p}_j . The idea is that a proper equilibrium stress “blocks” a strict infinitesimal motion between \mathbf{p}_i and \mathbf{p}_j when $\omega_{ij} > 0$. This is because $\sum_{i,j} \omega_{ij}(\mathbf{p}_j - \mathbf{p}_i)(\mathbf{p}'_i - \mathbf{p}'_j) = 0$, each $\omega_{ij}(\mathbf{p}_j - \mathbf{p}_i)(\mathbf{p}'_i - \mathbf{p}'_j) \leq 0$, and $\omega_{ij}(\mathbf{p}_j - \mathbf{p}_i)(\mathbf{p}'_i - \mathbf{p}'_j) < 0$ when both $\omega_{ij} < 0$ and $(\mathbf{p}_j - \mathbf{p}_i)(\mathbf{p}'_i - \mathbf{p}'_j) > 0$. The important thing to know is that the converse is true. In other words, if there is no proper equilibrium stress to block a strict infinitesimal motion between \mathbf{p}_i and \mathbf{p}_j , then there IS an infinitesimal motion of the tensegrity that is strict between \mathbf{p}_i and \mathbf{p}_j . This is an instance of the Farkas Alternative as used in linear programming. So the existence of the infinitesimal motion is “reduced” to the non-existence of strict proper equilibrium stresses on the given configuration.

The third observation is a geometric way of interpreting stresses in a framework in the plane. If you have a framework embedded in the plane with an equilibrium stress, there is a natural surface in three-space whose edges project orthogonally onto the edges of the framework as in Figure 2. Note that the faces do not have to be all triangles, but it is important that the surface in three-space be a disk or sphere. (Topologically, it has to be simply connected in order for the “lift” of the planar object to be well-defined.) The strength

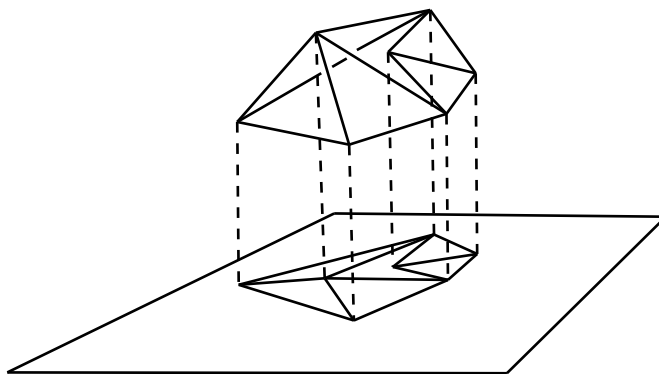

Figure 2: The projection of a polyhedral surface into the plane.

of this result, which was due to James Clerk Maxwell and Luigi Cremona in the nineteenth century, is that the lift of non-triangular faces must be planar in three-space. This result was revived and clarified in [Whiteley], where its importance to rigidity was shown. Another consequence of the Maxwell-Cremona correspondence is that the sign of the stress in the plane determines the convexity of the surface in the lift. This is shown in Figure 3. The

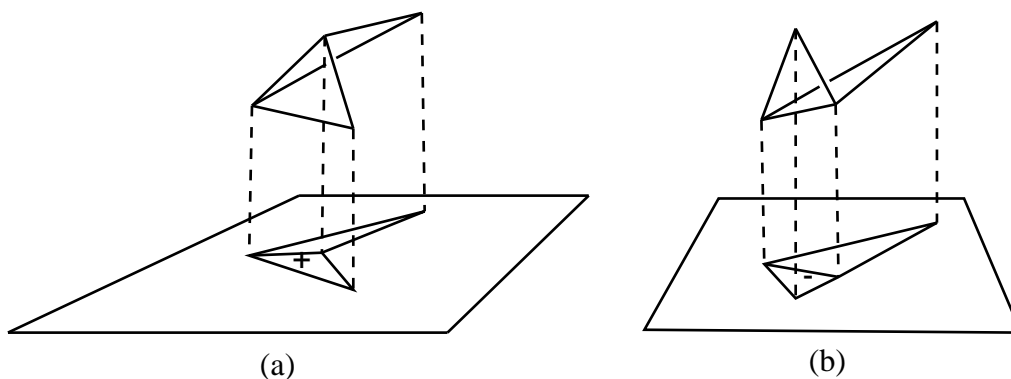

Figure 3: This shows two portions of a surface and their Maxwell-Cremona lifts. Figure (a) lifts to a surface that is a convex mountain fold because the corresponding stress on the middle edge is positive. Figure (b) lifts to a concave portion of the surface, corresponding to a valley fold, since the stress on the middle edge is negative.

Maxwell-Cremona lift then can be used to understand any possible equilibrium stress in the plane. However, the tensegrity framework that is needed for the question of whether there is an expansion motion in the plane seems to need the struts to cross each other, and the Maxwell-Cremona result needs the tensegrity framework to be embedded in the plane, or at least be such that the underlying surface is topologically a disk or a two-dimensional sphere. But this problem can be addressed by a standard technique. Simply put additional vertices at the crossings of the edges, struts or bars, making the underlying graph planar. This is shown in Figure 4. So now the problem of determining whether there is a proper non-zero equilibrium stress in the tensegrity of Figure 4 (a) can be determined by whether there is a

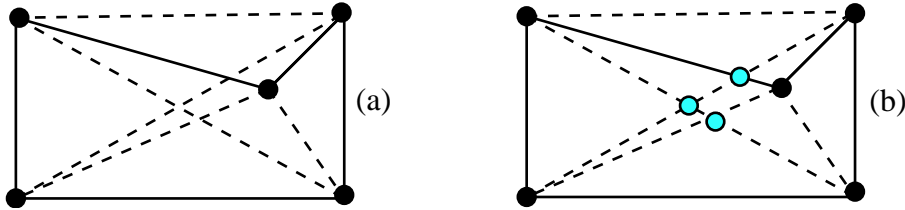

Figure 4: This shows the process of subdividing the original graph (a) with crossings to get another graph (b) without crossings. When the the dashed edges of graph (b) expand, so do the dashed edges of graph (a).

lift of Figure 4 (b).

So far, all of these techniques, the stress-motion duality, the creation of a planar graph, and the Maxwell-Cremona lift had been well-known in general, although not applied to the carpenter’s rule problem. The new idea is how to use the Maxwell-Cremona lift. Since the equilibrium equalities hold at the vertices of the boundary of the framework in the plane, the outside edges of the lift are planar. By adding an affine motion to the lift, for convenience, we can assume that these outside edges lift to a horizontal plane. The strut edges have a negative stress, and so their lifted edges have a valley fold. So there seems to be nothing to prevent a downward depression in the lifted surface. But the question is what happens at a maximum? Consider a single edge with a negative stress, where the level of one end vertex \mathbf{p}_1 is higher than the other \mathbf{p}_2 . In the Maxwell-Cremona lift, the edge corresponds to a valley fold. Consider also a plane parallel to the base plane P just below the lift of the upper vertex \mathbf{p}_1 . The projection into the base plane of the intersection of P with the lift is a level line L . This polygonal curve L , near the projection of \mathbf{p}_1 is two line segments that “turn away” from it as in Figure 5. Consider the set M in the base plane that correspond to the maximum points in the lift. Any point in the boundary of M in the interior of the convex hull of all vertices will have L as in Figure 5. But L must contain M and so must have a point on its boundary that “turns toward” its corresponding vertex of M . This is not possible as in Figure 6. The only time that the boundary can be the maximum set M is when all edges of the boundary have a positive stress, and all the edges of the boundary are part of the chain. This is because the Maxwell-Cremona lift is a closed surface and for a boundary edge, one adjacent face of that boundary edge is the base plane, and the other adjacent face will lie above the base plane when the stress is negative. So when we have an open chain, the only configuration that could possibly have a non-zero stress is when the chain is straight.

2 Locked configurations

It is easy to see that a convex polygon cannot be expanded any further. Indeed, in a convex configuration, one does not even need all the added struts to insure that the resulting tensegrity is rigid. For example, when the struts are placed as in what is called a *Cauchy polygon* in [Connelly] as shown in Figure 7 the tensegrity is infinitesimally rigid and it is *globally rigid* in the sense that there is not even any other configuration, except congruent copies, that have struts no shorter and corresponding boundary edges no longer.

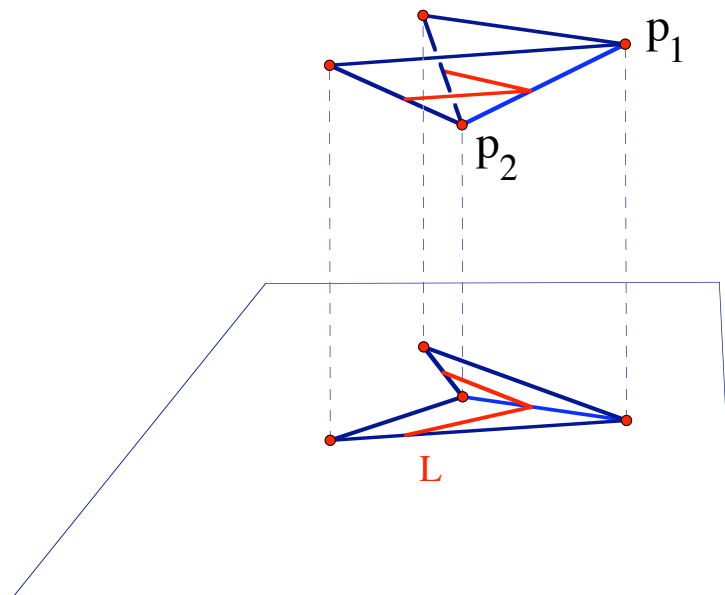

Figure 5: The lines in this Maxwell-Cremona lift show the level lines near an edge with a negative stress and a valley fold. Notice that the curve “points toward” the upper vertex.

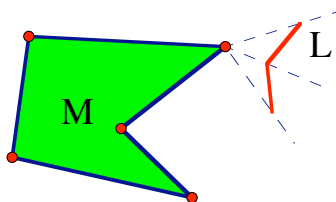

Figure 6: This shows the problem when the level line L is near a point in the convex hull of M , the points corresponding to the maximum set.

One natural question is just what sort of frameworks in the plane do allow a appreciable motion locally, even if it gets blocked later. One very cogent example had been found in [Beidl et al.] even before the expansive argument described in Section 1. This is shown in Figure 8. It is clear that the central vertex of this star shaped framework is the trouble maker. The configuration can wiggle around a bit, but, up to congruences, it cannot move too far. Of course, the arms have to be tucked sufficiently snugly into the arm pits to insure that the angle between adjacent large bars cannot decrease appreciably.

It is possible to create a model of locked frameworks, where bars can touch, but not cross, as a limit of such nearly touching frameworks. This is done in [Connelly-Demaine-Rote]. The constraints that only allow the appropriate vertices to move to one side, when they touch and edge, act as a kind of strut. The theory of infinitesimal motions and the dual stress analysis can also be applied. For example, this theory can determines that the configuration of Figure 9 is locked. It is a general principle of rigidity that when the limiting framework

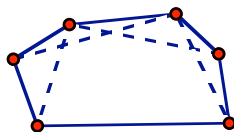

Figure 7: This is an example of a Cauchy polygon that is infinitesimally rigid and globally rigid.

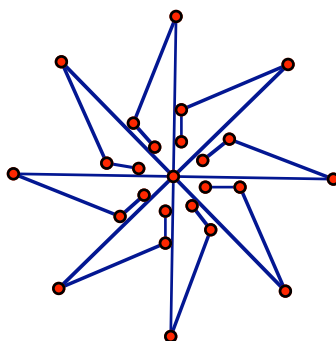

Figure 8: This is a tree that cannot open expansively, and, indeed, the branches of the tree cannot open at all without overlapping.

with touches is locked, then the embedded approximations have the property property that they cannot move too far from the limiting configuration, up to congruence. I called this *sloppy rigidity*.

3 Other expandable configurations

The ideas in Section 1 lend themselves to several extensions and generalizations. The most immediate extension is when the set to be expanded is a closed chain and the target configuration is when the chain is convex.

But the argument of Section 1 can be easily extended to handle arbitrary finite unions of closed chains and open chains as long as no closed chain contains another component in its interior, as in Figure 10. Even when one chain is contained inside another, the expansion is possible until the outer chain becomes convex.

The ideas of Section 1 were explained to Ileana Streinu at a workshop in Barbados in January of 2000, and later she made some very interesting observations [Streinu]. In order for the proof of the expansion property to work, all the interior vertices (those inside the convex hull) had to be such that their incident edges were inside a half plane through that vertex, as in Figure 11. She defined such vertices to be *pointed*. Of course, in addition to the vertices being pointed, some edge on the boundary of the convex hull must be a strut, as in Figure 11. So if that is the case, all vertices are pointed, and at least one edge on the boundary of the convex hull is a strut, then the tensegrity will have an infinitesimal expansion

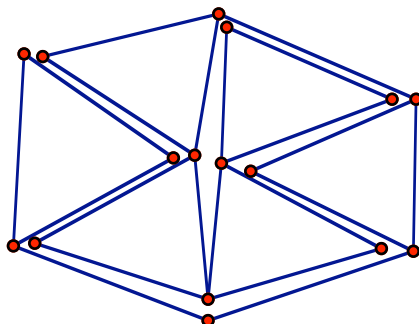

Figure 9: This is a chain of triangles and edges that is locked in the limiting configuration, or has sloppy rigidity in the sense that any configuration that is an approximation cannot be moved too far from the limiting configuration while fixing the bar lengths without creating self-intersections.

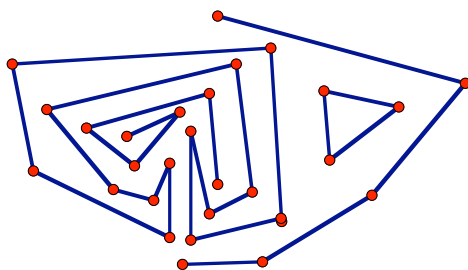

Figure 10: This shows a configuration of a union of chains that can open.

and a finite motion that is an expansion, at least for a short amount of time. The only way the motion can stop is if one of the internal vertices ceases to be pointed, or the boundary of the convex hull of the configuration becomes all bars.

But one of the most interesting parts of this observation is what happens when bars are added in such a way to maintain the property of being pointed. For example, a bar can be added to the graph in in Figure 12 (a) to get Figure 12 (b). When no more edges can be added maintaining the property of being pointed (with no edges crossing of course), one gets what she called a *pointed pseudo triangulation*, as in Figure 11. It turns out that each region for this configuration and graph is such that there are exactly three vertices, where a support line for being pointed has the region on the same side as the edges incident to the vertices. Such a region is called a *pseudo triangle*. An example is shown in Figure 13.

The best part of these observations is that they can be applied back to the original carpenter's rule problem for open or closed chains. The idea is that if there is a non-intersecting chain in the plane, one can add non-crossing bars until it becomes a pseudo triangulation. Such a bar framework has exactly the minimal number of bars ($2n - 3$ bars for n vertices) to be infinitesimally rigid, and a Maxwell-Cremona argument shows that there is no equilibrium stress. So such a bar framework is, indeed, infinitesimally rigid in the plane. But such a frameworks, called *isostatic*, have the property that removing one bar give the structure

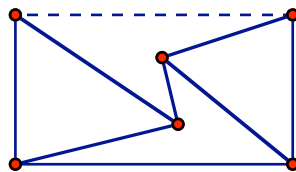

Figure 11: A vertex is called *pointed* if all the edges incident to it lie on one side.

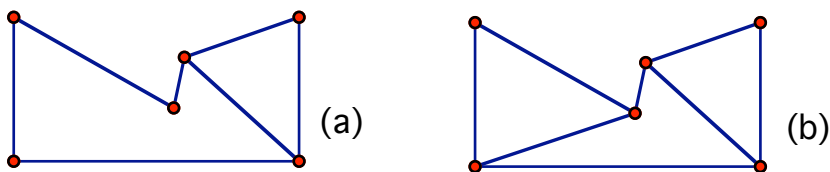

Figure 12: An edge is added to the graph of part (a) to get the graph of part (b), such that all the vertices remain pointed.

one degree of freedom as in Figure 11. When a bar on the boundary of the convex hull is replaced by a strut, then the Maxwell-Cremona argument can be further extended to show that not only is there a finite motion of the tensegrity, its motion is automatically an expansion (possibly not strict). If the chain is not convex, the strut on the boundary can be taken to be not in the chain. So expansive progress is made. But during the motion some vertices may become not strictly pointed. When that happens one can either freeze two bars of the chain into one, or find another pointed pseudo triangulation using the the same chain. In any case, she proves that there are, at most, on the order of n such re-pseudo triangulations, where n is the number of vertices of the chain.

So this process provides another algorithm to open chains. It has the very appealing property that the motion at any time has only one degree of freedom. So if one were to physically built such a mechanism, it could be controlled by simply expanding some pair of vertices, not connected in the chain, on the boundary of the convex hull of the configuration, for example. But as far as the formal computational time complexity of this algorithm, and the one described in Section 1, they are essentially the same. Both algorithms involve integrating a vector field in the space of configurations, punctuated by, at most, order n changes in the underlying graph or pseudo triangulation. On the other hand, the algorithm of Section 1 has the property that it is *canonical*, which means that there is no choice involved as to what the straightening path is. Small changes in the input configuration imply that there are correspondingly small changes in the straightening path. Technically, the process describes a strong deformation retract of the space of configurations onto the space of convex chains.

But neither of these straightening algorithms is the the winner as far as computational simplicity and lack of complexity. The best algorithm seems to be the one described in [Cantarella-Johnston]. One very natural method to convexify a closed chain for the carpenter's rule problem is to use energy functions defined on the configuration space and

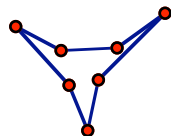

Figure 13: A pseudo triangle.

then proceed following a gradient flow to a local minimum. For example, define $E(\mathbf{p}) = \sum_{ij} f(|\mathbf{p}_i - \mathbf{p}_j|)$ on the space of configurations with the given bar lengths, where $f(x)$ is a real valued function such that it is strictly monotone decreasing and goes to infinity or at least gets very large as x goes to 0. The problem with this approach, as with others of this sort, is that there seems to be no guarantee that the final configuration, which is a local minimum, will be convex. However, that is not the case. It is pointed out in [Cantarella-Johnston] that such a method always works. The point is that the energy function always has the option of increasing the distances between all the nodes not connected by bars by argument in Section 1, and so there never can be a non-convex configuration that is at a local minimum. The motion may decrease some pairs of distances during the intermediate motion, but ultimately it will arrive at a convex configuration. It is also pointed out in [Cantarella-Johnston] that implementations of this algorithm seem to be somewhat faster, more accurate, and more efficient than those using the algorithm in Section 1.

But an expansion can be applied to other circumstances other than just linear or closed chains. There are two situations that stop the expansive motion; some vertex is not pointed or a cycle of edges becomes convex. One can *freeze*, i.e. hold rigid, all the vertices adjacent to any vertex that is not pointed. If any two of these frozen sets intersect in more than one point, we freeze the convex hull of their union. And lastly if any cycle of edges becomes convex, we freeze that cycle and anything in its interior. In that way we arrive at a configuration that has no expansion possible. This is shown in Figure 14. Notice that as a set is frozen,

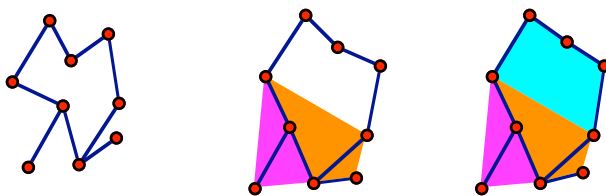

Figure 14: A sequence of expansions, where different parts are frozen until the final configuration is not expandable.

its interior is disregarded and bars are inserted along its boundary and considered for the property of being pointed. As one set is frozen, it can automatically freeze other sets as happens in the first step of Figure 14. Notice that if anything more than one point of an edge appears in a frozen set, it and the frozen set get frozen together in their convex hull. But if an one vertex of an edge intersects a newly formed frozen set, then it can be allowed to move away from it as in Figure 15 in the spirit of Section 2.

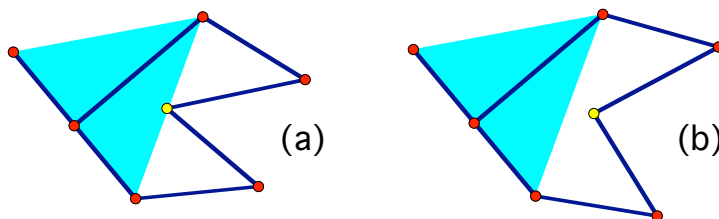

Figure 15: It can happen that one end of an edge nips the side of a newly frozen set as in Part (a). But it is still allowed to move away from it expansively as in Part (b).

Putting all this together, we have the following.

Theorem 3.1 (Expanding frameworks). *Any embedded framework in the plane can be expanded until the frozen portion is the whole set.*

4 Straightening non-expansively

There are circumstances where one may wish to “open” a framework in the plane, and yet there is no continuously expansive motion available. But there may be an expandable “core” which can be used. One idea, as discussed in [Connelly et al.], is to add what are called *slender adornments*. These are sets attached to the bars of an expanding framework in the following manner. Each set is determined by a region bounded by a curve, one side of which is the bar and the other side is a curve from one end point of the bar to other such that the straight line distance from a point on that curve to each of the endpoints is monotone (but not necessarily strictly monotone). This is shown in Figure 16. A moment’s thought shows

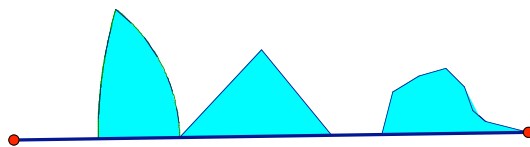

Figure 16: An example of a bar with a slender adornment attached.

that this is the same as requiring that an adornment is an arbitrary union of the intersection of pairs of disks centered at the end points in one half plane having the bar as a boundary. This is shown in Figure 17. The main result of [Connelly et al.] is that if slender adornments are attached to edges of a continuously expanding framework so that their interiors do not overlap, then these adornments are carried along with the expanding motion, and they still do not overlap while the core expands. Call the intersection of two disks as in Figure 17 a *lens*, and the part on one side of the line through the edge, as is shaded inside the triangle of as in Figure 17 a *half-lens*. Every slender adornment is the (possibly infinite) union of such half-lenses.

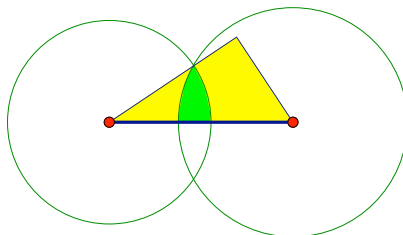

Figure 17: This shows an intersection of two disks in the upper half plane, inside a slender adornment, where the adornment is a right angled triangle.

But the interesting part of this result is that the distance between pairs of points in the adornments may get smaller during the motion, but nevertheless they will not come in to contact. This is shown in Figure 18.

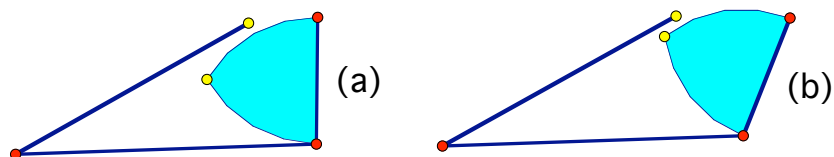

Figure 18: When the core chain of Part (a) is expanded to Part (b), the light colored point in the slender adornment gets closer to the other light colored point in the chain, but they do not intersect, a near miss.

To see why slender adornments don't overlap when their cores are continuously expanded, it is helpful to look at a slightly altered question. Suppose that we ask what happens to slender adornments when one core is discretely expanded to another configuration without a continuous motion in between. This can cause an unwanted overlap as with the example in Figure 19. A very natural method of dealing with this problem is to insist that the adornments

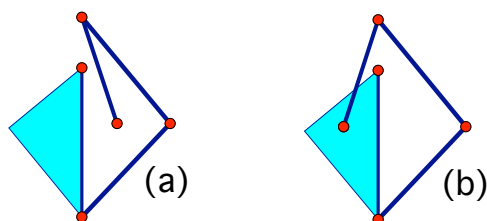

Figure 19: Here a chain, the thick bars, is expanded from one configuration (a) to another (b), but when a slender (one-sided) adornment is attached, it can result in some unwanted overlaps.

are *symmetric*, which means that each adornment is symmetric about the bar it is attached to, as in Figure 20. It is easy to show that if all the slender adornments are symmetric

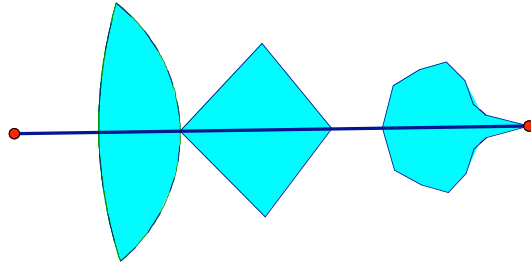

Figure 20: This is the symmetrized version of Figure 16.

and are attached with disjoint interiors, then under any discrete expansion the adornments still do not intersect in their interiors. This follows easily from the characterization of each slender symmetric adornment as the union of the intersection of pairs of disks centered at the end points of each segment. If two adornments, from two different edges in the framework, intersect, then some four circular disks at the end points of the two line segments must intersect. The starting configuration is such that their interiors do not intersect, but when the centers are expanded, suppose they do intersect in their interiors. But this contradicts a famous theorem of Kirszbraun [Kirszbraun]. See Figure 21. So the behavior of Figure 19 cannot occur. This gives us the following result.

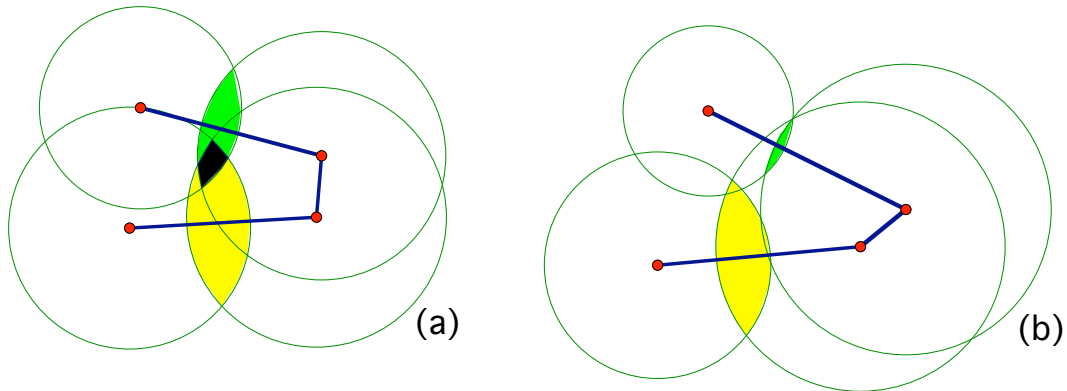

Figure 21: The slender symmetric adornments for the upper and lower edges intersect in (a), and this implies that there are four circular disks that must also intersect. The shaded parts of the slender adornments in (b) do not intersect, and so the four circular disks do not intersect. Kirszbraun's Theorem implies that if the centers of these four disks are expanded, the corresponding disks will still not intersect.

Theorem 4.1. *If one framework \mathbf{p} in the plane expands to another \mathbf{q} , and slender symmetric adornments, with disjoint interiors, are attached to the edges of \mathbf{p} , they remain disjoint when attached to the corresponding edges of \mathbf{q} .*

But back to the case when the slender adornments are one-sided, but the expansive motion is continuous. If some pair of points in adornments attached to different edges intersect at

some point, some pair of half-lenses must start to penetrate each other. There are three ways this can happen as shown in Figure 22. In each case, the adornments cannot penetrate each

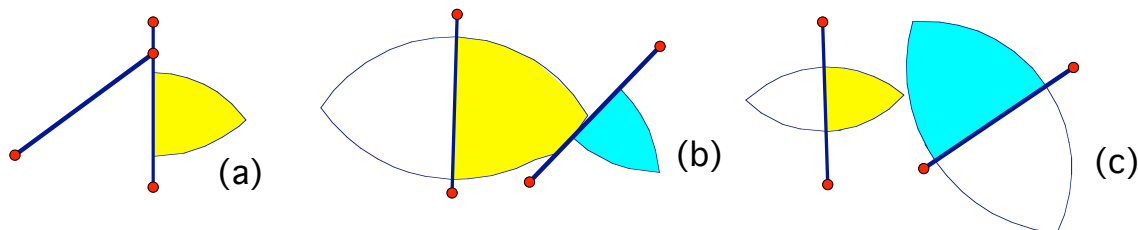

Figure 22: Part (a) shows the case when two points from the expanding core might overlap. This cannot happen since the core is expanding. Part (b) shows the case when an adornment intersects the core. If we extend the half-lens in the adornment to its symmetric other half, penetration into the adornment cannot happen by the application of Kirszbraun's Theorem above. (Two of the circles are tangent.) Part (c) shows the case when half-lenses in two adornments intersect. In this case both half-lenses can be symmetrized, and again they cannot penetrate each other by Kirszbraun's Theorem.

other. This brings us to the main result of [Connelly et al.].

Corollary 4.2. *If a framework is continuously and monotonically expanded in the plane and adornments are attached, with disjoint (possibly one-sided) interiors, they remain disjoint as they are carried along by the continuous motion.*

When the adornment being attached to an edge is a triangle, with the base of the triangle forming the edge, it is a slender adornment if and only if the angle opposite the base is obtuse, the limiting case of a right triangle being allowed. Figure 9 shows a case when adornments are not slender, and in this case the configuration is locked, as discussed in Section 2.

5 Extensions and related matters

The argument with lenses in Section 4 has a striking similarity to some recent results concerning Kneser-Poulsen Theory and this leads to some interesting generalizations. See [Bezdek-Connelly] and the history related there. In the 1950's Kneser and Poulsen independently conjectured that if a finite set of circular disks in the plane (or in higher dimensions) were repositioned so that the distance between the centers of every pair of corresponding disks expanded (or stayed the same), then the area of the union increased or stayed the same. It was later shown [Csikós] that this conjecture is true in any dimension if the expansion of the centers can be achieved monotonically and continuously, and it is shown in the plane for any discrete expansion in [Bezdek-Connelly]. But the point is that in [Gordon-Meyer] the Kneser-Poulsen questions are generalized considerably to much more arbitrary unions and intersections of a finite number of disks (in any dimension), objects they called *flowers*. In all of these cases, in the plane, the appropriate Kneser-Poulsen conjecture about areas has been proved in [Bezdek-Connelly]. One very special case of a flower is the arbitrary (finite)

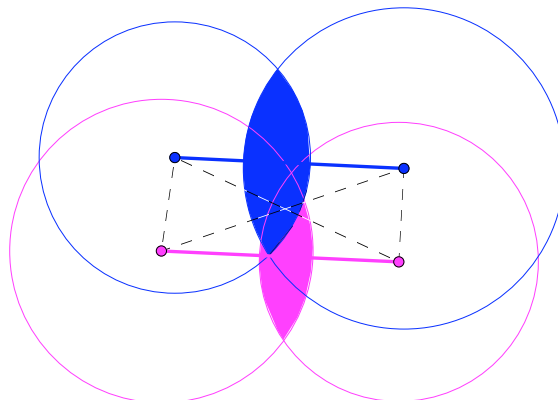

Figure 23: This is a special case of an arrangement of circles that have the property when the dashed edges between centers of circles expand, and the solid edges contract (perhaps not strictly), then the area of the union expands (perhaps not strictly) and the area of the intersection contracts (perhaps not strictly). This holds for any discrete repositioning by [Bezdek-Connelly].

union of intersections of pairs of disks. Figure 23 shows two pairs of disks. When the solid edges are contracted, and the dashed edges are expanded, the area of the union of the two pairs of intersections increases. In the case of a single symmetric adornment, the circles are all concentric to one of the two end points of the core edge, and there is no proper expansion or contraction possible. The motion has to be a rigid congruence. But if the circles are as in Figure 23, then the area of the union will expand and the area of the intersection of the two adornments will contract (perhaps not strictly). It is easy to see that any symmetric adornment can be approximated by a finite union of pairs of intersections of disks and the results in [Bezdek-Connelly] imply that when the adornments overlap, as the core expands, the area of the union of all the adornments must expand, and the area of the intersection of any two adornments must contract (perhaps not strictly).

Theorem 5.1. *If one framework \mathbf{p} in the plane expands to another \mathbf{q} , and slender symmetric adornments are attached to the edges of \mathbf{p} , the area of the union of the adornments increases or stays the same when attached to the corresponding edges of \mathbf{q} .*

References

- [Asimow-Roth] Asimow, L.; Roth, B., The rigidity of graphs. *Trans. Amer. Math. Soc.* 245 (1978), 279–289. MR 80i:57004a
- [Asimow-Roth II] Asimow, L.; Roth, B., The rigidity of graphs. II. *J. Math. Anal. Appl.* 68 (1979), no. 1, 171–190. MR 80i:57004b
- [Bezdek-Connelly] K. Bezdek and R. Connelly, Pushing disks apart - the Kneser-Poulsen conjecture in the plane, *J. reine angew. Math.*, vol. 553, 221–236 (2002)

- [BDDLORSTW] A Note on Reconfiguring Tree Linkages: Trees can Lock, Therese Biedl, Erik Demaine, Martin Demaine, Sylvain Lazard, Anna Lubiw, Joseph O'Rourke, Steve Robbins, Ileana Streinu, Godfried Toussaint, and Sue Whitesides, *Discrete Applied Mathematics*, volume 117, number 1-3, 2002, pages 293-297.
- [Cantarella-Johnston] Jason Cantarella and Heather Johnston, Nontrivial Embeddings of Polygonal Intervals and Unknots in 3-Space, *J. Knot Theory Ramifications*, Vol. 7, No. 8 (1998) p. 1027-1039.
- [CDDFLMRR] Robert Connelly, Erik D. Demaine, Martin L. Demaine, Sándor P. Fekete, Stefan Langerman, Joseph S. B. Mitchell, Ares Ribó, Günter Rote, Locked and Unlocked Chains of Planar Shapes, *Proceedings of the 22nd Annual ACM Symposium on Computational Geometry (SoCG 2006)*, Sedona, Arizona, June 5-7, 2006, pages 61-70.
- [Connelly] Connelly, Robert, Rigidity. *Handbook of convex geometry*, Vol. A, B, 223–271, North-Holland, Amsterdam, 1993. MR 94j:52041
- [Connelly-Demaine-Rote] R. Connelly, E. D. Demaine, G Rote, Straightening polygonal arc and convexifying polygonal cycles, *Discrete and Computational Geometry*, 30(2):205-239, September 2003.
- [Connelly-Demaine-Rote-2] R. Connelly, E. D. Demaine, G. Rote, Infinitesimally locked self-touching linkages with applications to locked trees. In J. Calvo, K. Millett, *Linking and folding of Geometric Objects in 3-space*, pages 287-311. American Mathematical Society, 2002.
- [Connelly-Whiteley] Robert Connelly and Walter Whiteley, Second-order rigidity and prestress stability for tensegrity frameworks. (English. English summary) *SIAM J. Discrete Math.* 9 (1996), no. 3, 453–491. MR 97e:52037
- [Demaine-O'Rourke] Erik Demaine and Joseph O'Rourke, A Survey of Folding and Unfolding in Computational Geometry, *Combinatorial and Computational Geometry*. Eds. Jacob E. Goodman, Janos Pach, Emo Welzl, *Mathematical Sciences Research Institute Publications*, Vol. 52, Cambridge University Press, 2005, pp. 167-211.
- [Gordon-Meyer] Y. Gordon and M. Meyer, On the volume of unions and intersections of balls in Euclidean space, *Operator Theory: Advances and Applications*, vol. 77 91-101 (1995) MR96h:52008
- [Kirszbraun] M. D. Kirszbraun, Über die zusammenziehenden und Lipschitzschen Transformationen, *Fund. Math.* 22 (1934), 77-108.
- [Kneser] M. Kneser, Einige Bemerkungen über das Minkowskische Flächenmass, *Arch. Math.*, 382–390 (1955) MR17,469e
- [Poulsen] E. T. Poulsen, Problem 10, *Mathematica Scandinavica*, vol 2, 346 (1954)
- [Streinu] Ileana Streinu, Pseudo-Triangulations, Rigidity and Motion Planning in *Discrete and Computational Geometry* , vol. 34, no. 4, pp. 587-635, Nov. 2005.

[Whiteley] Walter Whiteley, Motions and stresses of projected polyhedra. With a French translation. *Structural Topology* 1982, no. 7, 13–38.

Department of Mathematics, Malott Hall, Cornell University, Ithaca, NY 14853
connelly@math.cornell.edu